

# Irrigation and Drainage Engineering

(Soil Water Regime Management)

(ENV-549, A.Y. 2025-26)

4ETCS, Master option

**Prof. Paolo Perona**

Platform of Hydraulic Constructions



Lecture 13-1. Execution of drainage

# Building drainage networks

- Backhoe
- Wheel excavators or chain excavators
- Mole drains

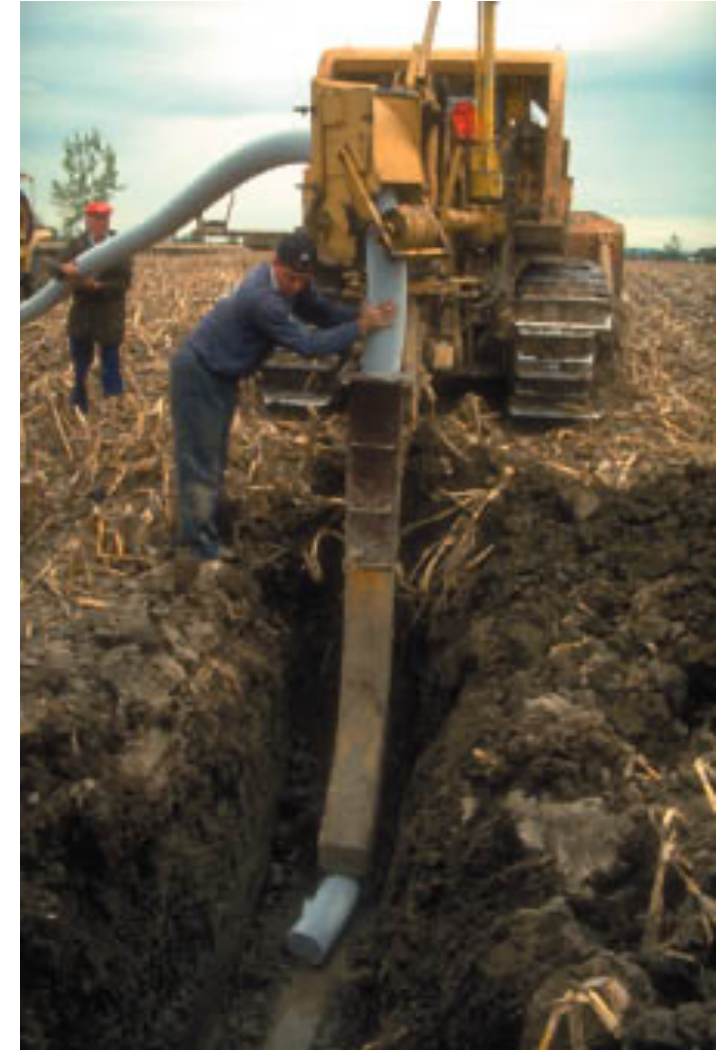

## Backhoe

### Advantages :

- versatile machine
- suitable for all types of soil

### Disadvantages :

- slow ( $10^1$ - $10^2$  m/h depending on depth)
- trench bottom to be adjusted manually
- large volumes excavated

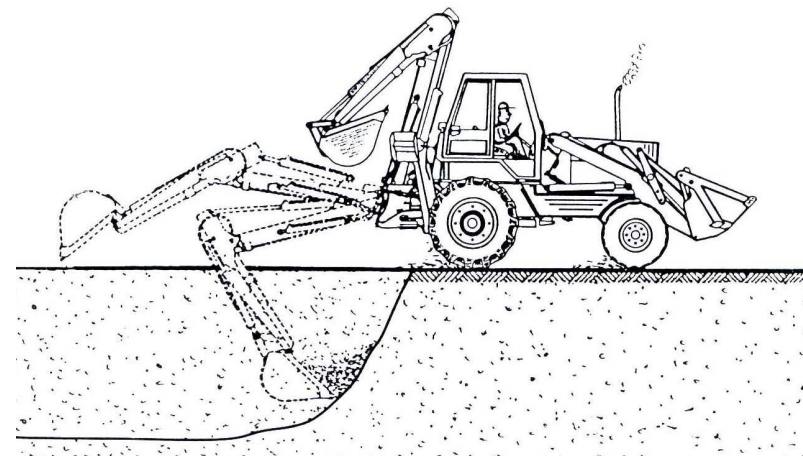

## Wheel excavators

### Advantages :

- rapid advance (1500 to 3000 m/h)
- control of slope and drain installation
- accessible trench (30 - 60 cm)

### Disadvantages :

- large volume excavated
- difficulties in rocky terrain

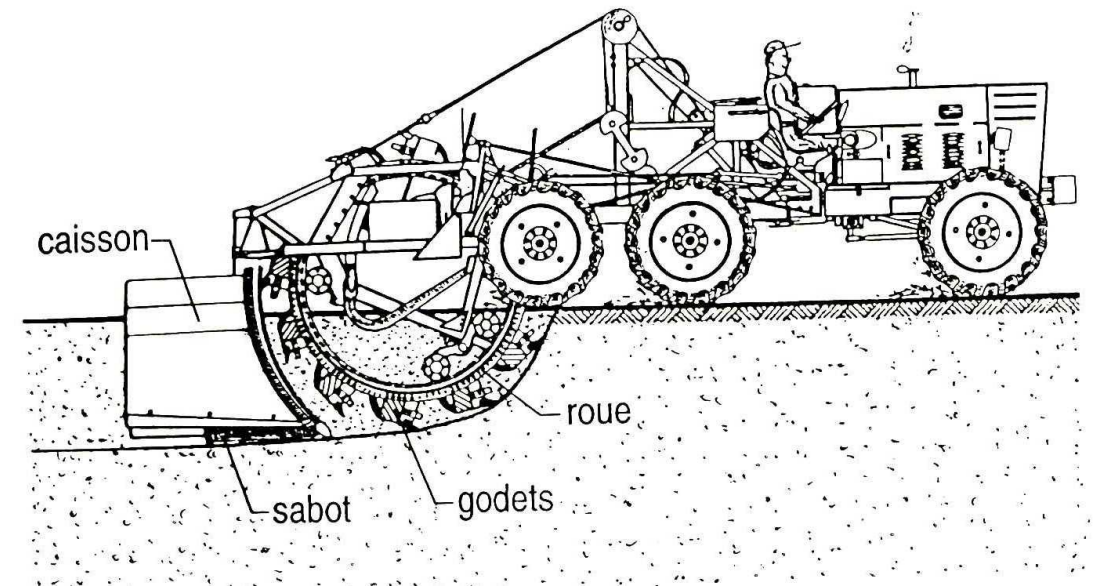

## Chain excavators

### Advantages :

- rapid advance (1500 to 3000 m/h)
- control of slope
- automatic drain laying (controlled)

### Disadvantages :

- difficulty getting down into the trench (25 - 40 cm)
- difficulties on rocky ground

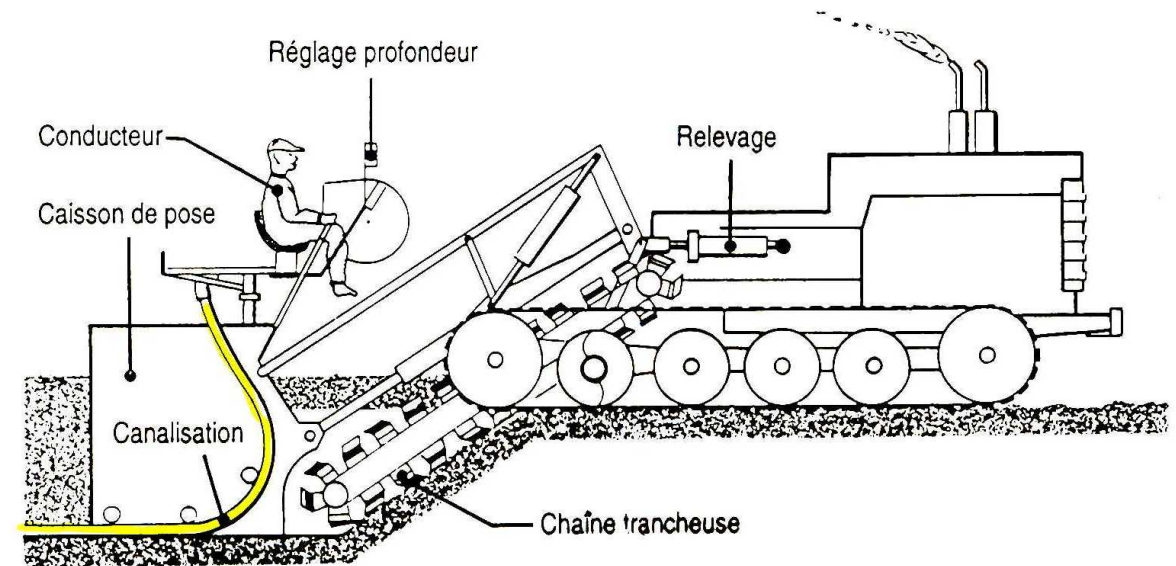



## Mole drains excavators

### Advantages:

- fast working (3000 to 4000 m/h)
- no backfilling
- withstands slightly rocky ground

### Disadvantages :

- limited to flexible hoses
- difficult to fit filters
- difficult to correct on the pipe
- excavator needed for collectors

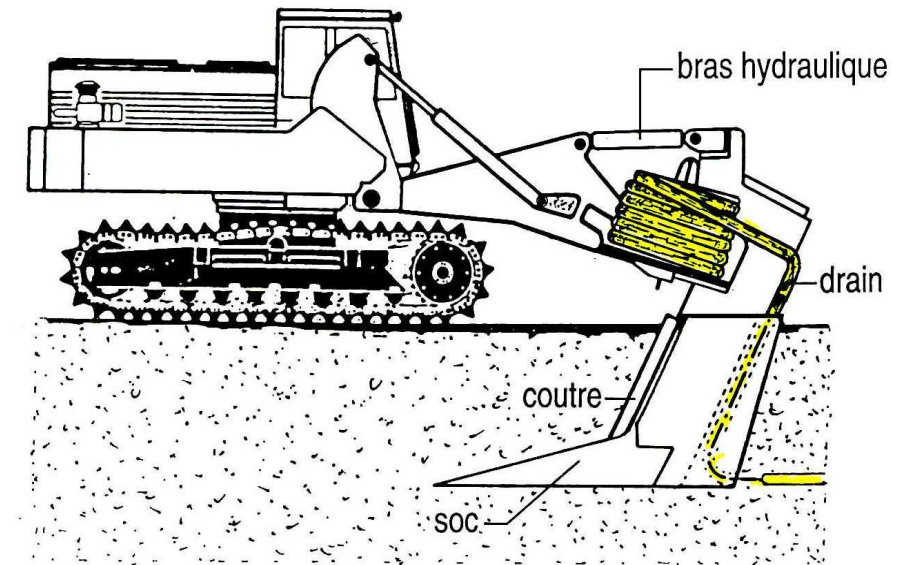

# Laser guidance of excavation machines

## Laser line (old systems, rarely used today)

Laser beam

(max. range : env. 300m)

The direction and slope of the drains are controlled by a receiving screen fitted with photocells and mounted on the draining machine. When the beam moves away from the target, the machine corrects the direction or depth until the beam returns to the centre of the target.

**Necessary movements and re-positioning :**

- for each change of slope
- for each new row of drains



## Automatic laser guidance (old, still used today)

- transmitter
- receiver mounted on a telescopic mast
- metric counter which records the distance from the start of the trench
- control and adjustment box; displays the desired slope in relation to the axis or reference plane. The system also calculates and adjusts the height of the receiver on the trench floor.



**Fixed laser:** defines a reference axis and does not need to be moved if the slope changes.

**Rotating laser:** defines a reference plane and only needs to be moved a few times once the area covered has been completed.

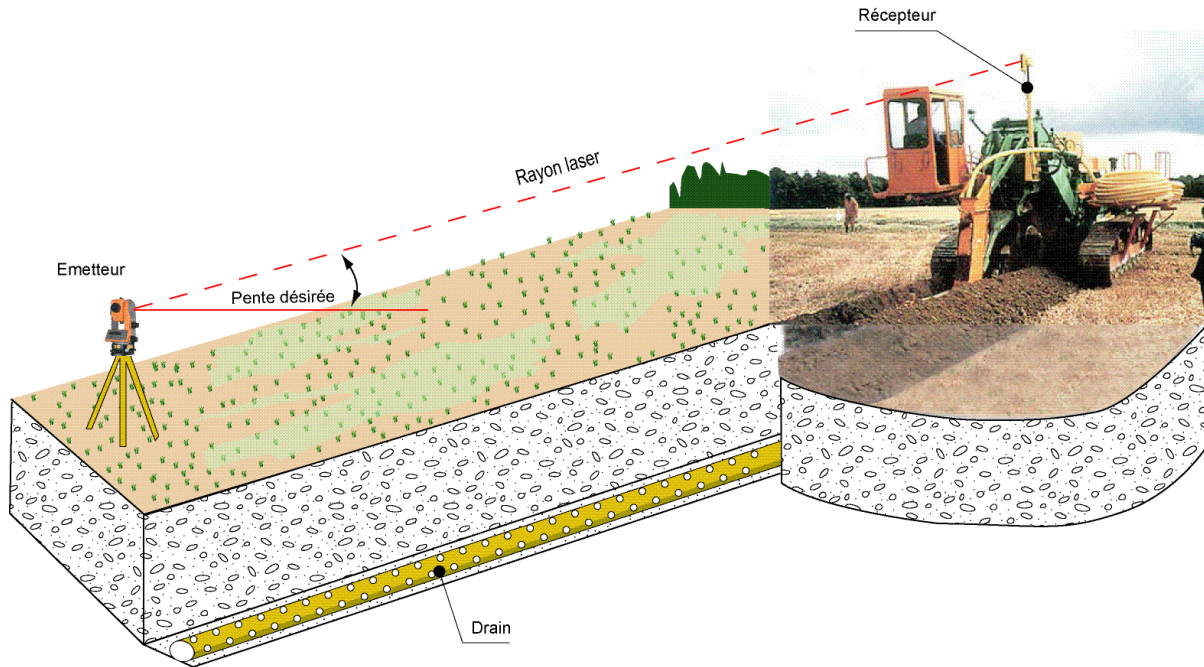

Laser line

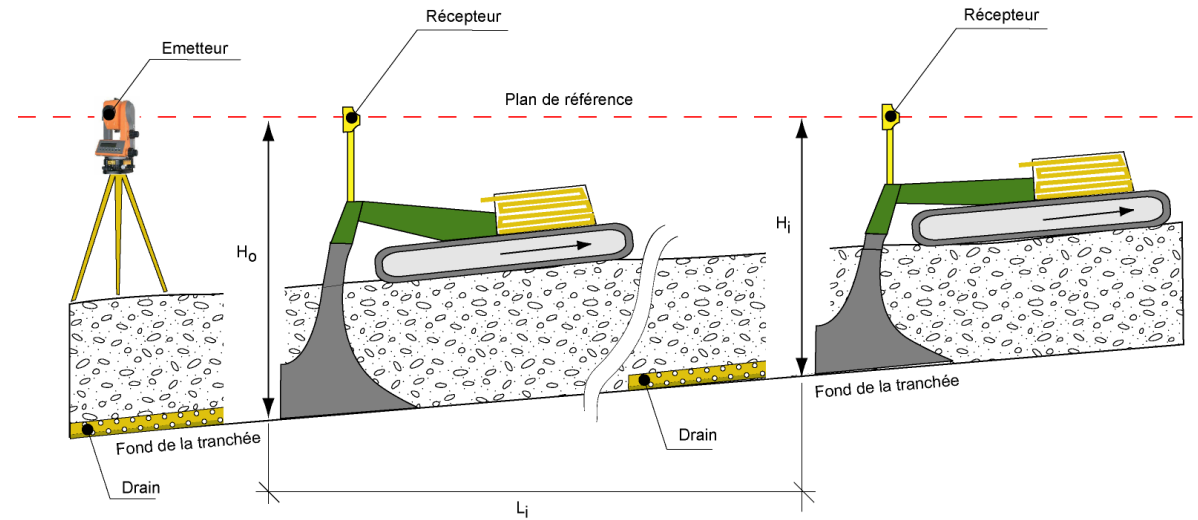

- H : hauteur du récepteur sur le fond de tranchée
- $H_0$  : hauteur initiale du récepteur
- P : pente de la tranchée
- L : distance parcourue

$$H_i = H_0 - p L_i$$

Automatic laser guidance

# Maintenance of drainage systems

## Phenomena requiring maintenance :

- silting and siltation
- ferric hydroxide deposits
- root penetration
- proliferation of algae and fungi
- defective construction (collapsing drains, sloping surfaces, manufacturing faults, burst pipes, etc.)
- filter clogging



## Localized phenomena:

roots, animals, deposits, collapsing and ruptured drains, faulty connections, etc.

## Remedy

- excavation downstream of the area where the water is rising
- cut out or dismantle the section of drain
- clear the obstruction
- re-establish the drain
- purge the line of drains using a high-pressure device to eliminate deposits upstream of the obstruction

## Systematic phenomena:

silting, siltation, iron and biological deposits,  
etc.

## Remedy

- high-pressure draining
- in the event of minor silting and recent iron deposits: low-pressure draining
- clogged filters, heavy iron deposits, collapsed drains: total or partial reconstruction of the network

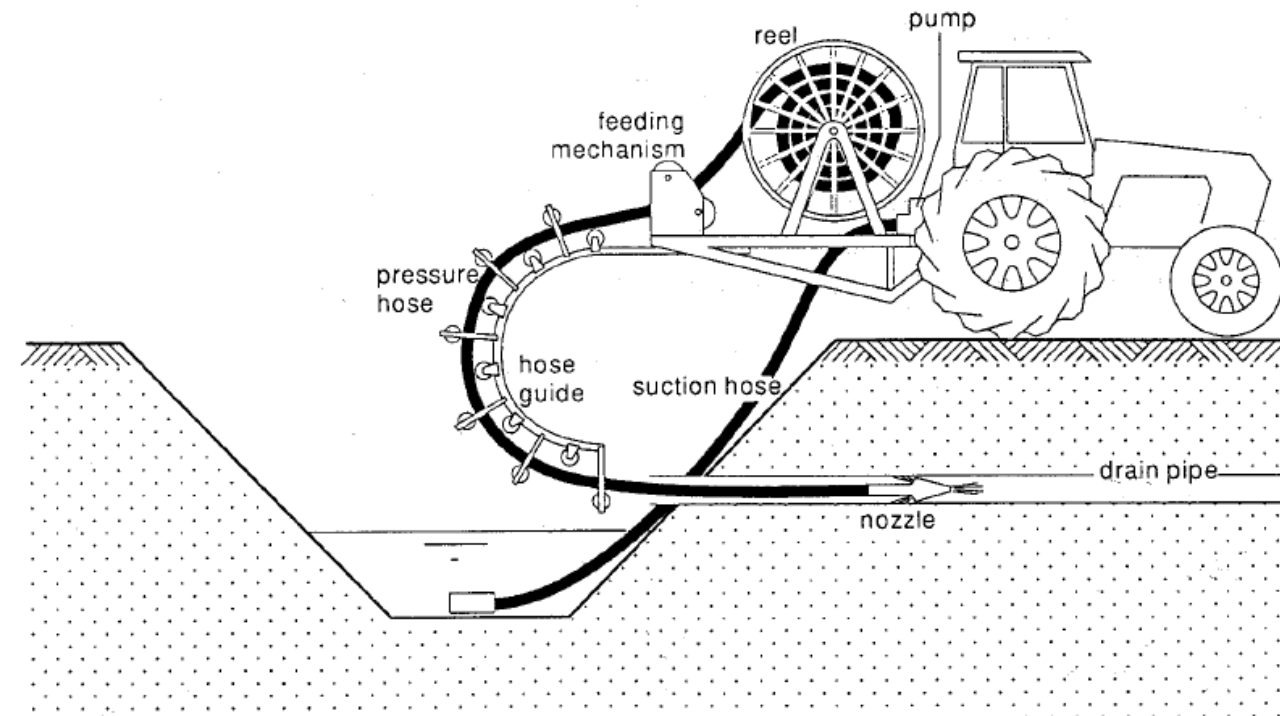

**High-pressure purging machine**

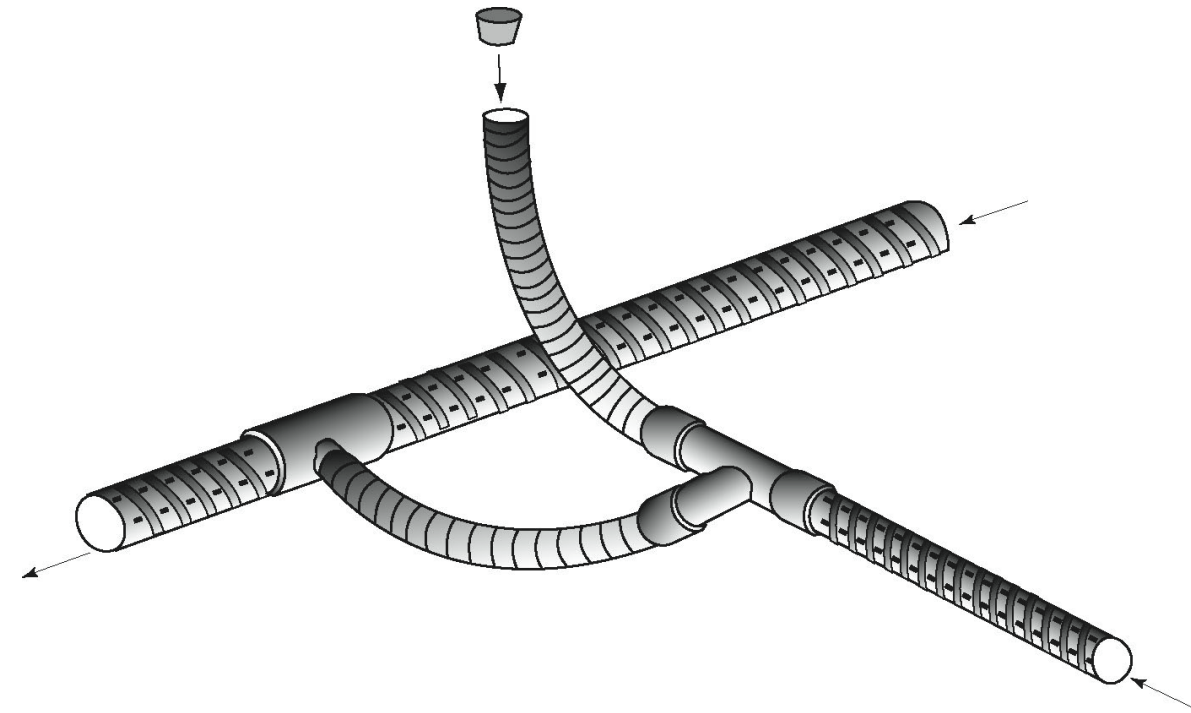

**Drain access device**